

# LAMP® SLUN-N SWING LIFT UP MECHANISM PAT

For proper installation and operation, we recommend that you read and follow these instructions carefully.

- Sugatsune cannot accept any claim for damages or injuries caused by improper use of this swing lift-up stay. Please refer to the "Model Selection" section below for the proper range of use.
- Sugatsune's liability is limited to the repair or replacement of a defective product. It shall in no way extend to the assembly as a whole.
- The utmost care was taken during the production of the SLUN-N. Should you however notice any defect, please notify your local dealer or Sugatsune (export@sugatsune.co.jp).
- The warranty period extends to one year from the shipping date.
- For improvement reasons, the content of this set may be changed without prior notice. We recommend that you check carefully the set content against the part list shown below and report any discrepancy to your local dealer before installation.
- Operating temperature is 5~35°C. Function may vary depending on the temperature.

- ⚠ Do not force the door open past its fully opened position.
- ⚠ Do not use in excessively hot environment such as to hide an oven.
- ⚠ Do not insert your hand or finger between the arms as this may lead to severe injury.
- ⚠ Never attempt to open or disassemble the mechanism as this may lead to injury.
- ⚠ Do not pull the arm down as it will spring back up violently and may cause serious injuries.

## Parts list

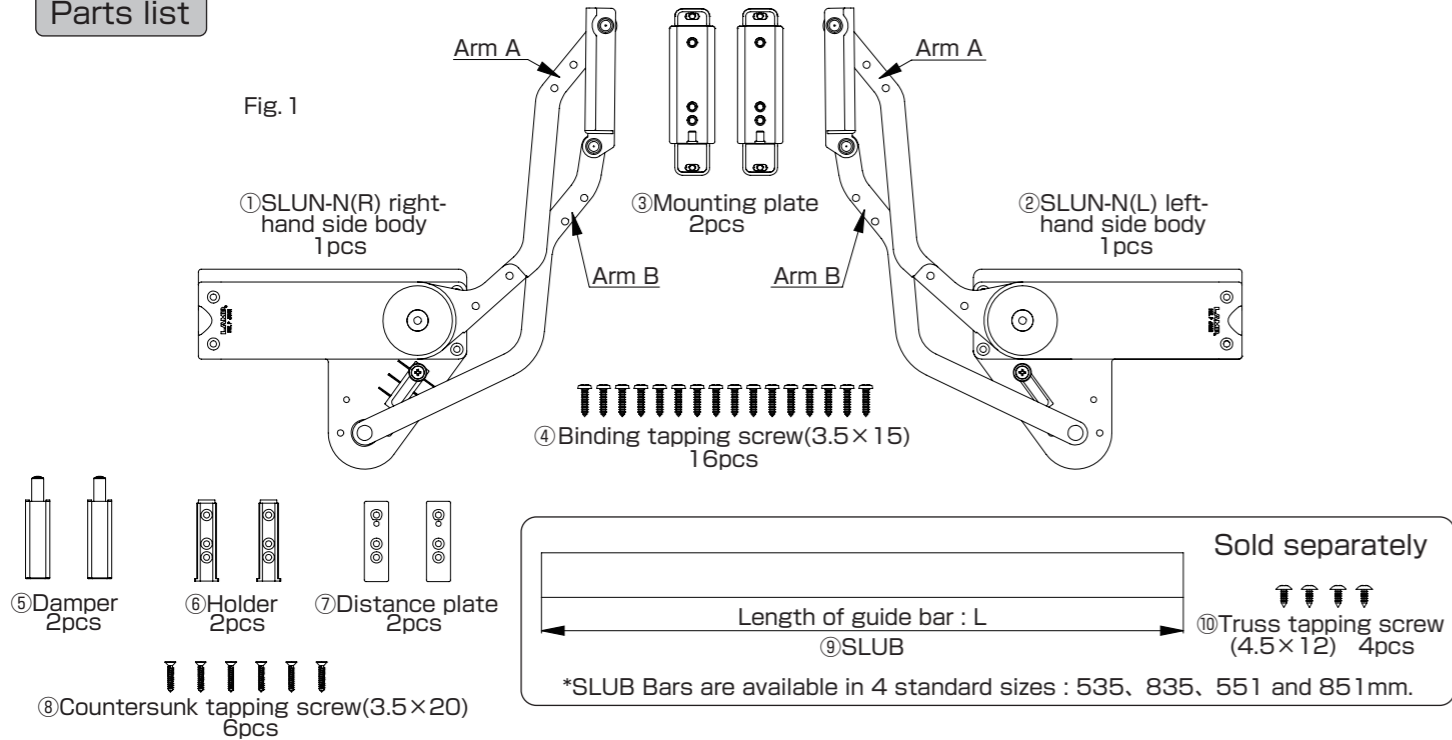

## Model selection

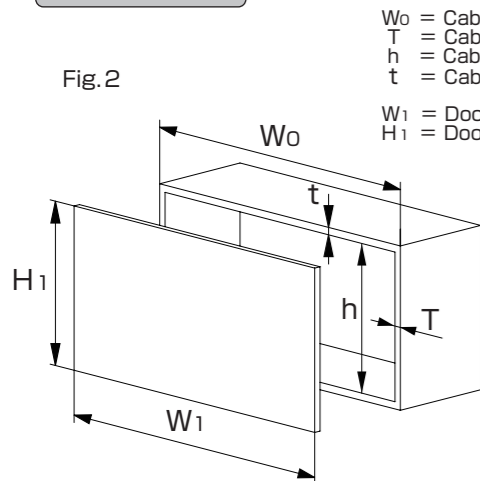

$W_0$  = Cabinet width  
 $T$  = Cabinet side panel thickness  
 $h$  = Cabinet inside height  
 $t$  = Cabinet top board thickness  
 $W_1$  = Door width  
 $H_1$  = Door height

Applicable door weight:	Door size:
SLUN-3N 2.8~3.8 kg	Width ( $W_1$ ) 600, 900mm
SLUN-4N 3.8~4.8 kg	Height ( $H_1$ ) 390~450mm
SLUN-5N 4.8~5.8 kg	

Select the SLUN type according to the weight of the door (including the handle).

SLUB bar needs to be cut depending on the cabinet width  $W_0$  and side panel thickness  $T$ . Bar length  $L$  will depend on whether it is installed on Arm A or Arm B (see Fig. 1).

Arm A installation:  $L = W_0 - (T \times 2) - 35$   
 Arm B installation:  $L = W_0 - (T \times 2) - 19$

**SUGATSUNE KOGYO CO.,LTD.**  
 Phone: +81 3 3866 2260  
 F a x : +81 3 3866 4447  
 E-mail: export@sugatsune.co.jp  
 Website: www.sugatsune-intl.com

**SUGATSUNE KOGYO (UK) LTD.**  
 Phone: +44 118 9272 955  
 F a x : +44 118 9272 871  
 E-mail: sales@sugatsune.co.uk  
 Website: www.sugatsune.co.uk

**SUGATSUNE AMERICA, INC.**  
 Phone: +1 310 329 6373  
 F a x : +1 310 329 0819  
 E-mail: sales@sugatsune.com  
 Website: www.sugatsune.com

**SUGATSUNE SHANGHAI CO., LTD.**  
 Phone: +86 21 3632 1858  
 F a x : +86 21 3632 1868  
 E-mail: lamp@sugatsune.com.cn  
 Website: www.sugatsune.com.cn

ISO9001(Japan Offices and Sugatsune America) and ISO14001(Chiba Production division and Logistic center), certified.

2012.12 PRINTED IN JAPAN 0541-3

## Dimensions

\*The drawing shows the application for the cabinet with 3mm thick seal gasket on front edge.

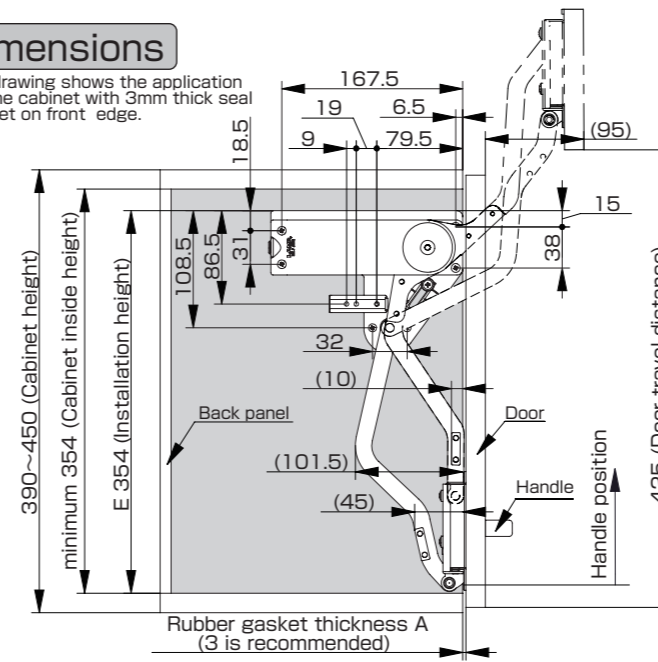

Fig.3 Dimensions

$$B = 244 + t + C + (h - 354)$$

$$E = 354$$

$$D = 32 + T - \left( \frac{W_0 - W_1}{2} \right)$$

$W_0$  = Cabinet width  
 $T$  = Cabinet side panel thickness  
 $h$  = Cabinet inside height  
 $t$  = Cabinet top board thickness  
 $W_1$  = Door width  
 $C$  = Clearance (minimum 2.4)

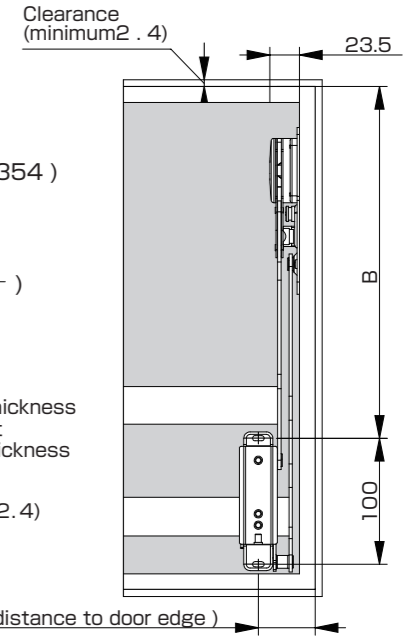

## Installation

### 1. Body installation:

- (1) Draw a horizontal line at 354mm from the inside bottom of the cabinet.
- (2) Line up the steel plate of the SLUN-N bodies ① and ② to the front of the cabinet and the line drawn in (1).
- (3) Use screws ④ to secure both bodies to the cabinet.

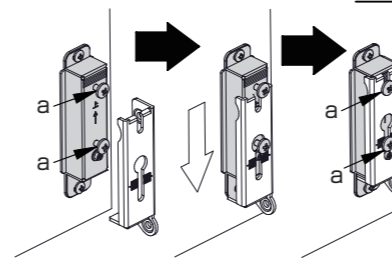
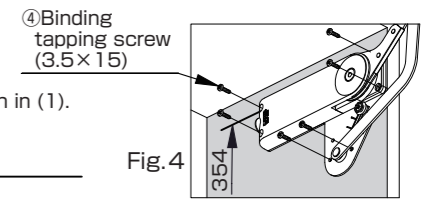

### 2. Door installation:

- (1) Install the mounting plates ③ to the back side of the door as per dimensions shown in Fig.3.
- (2) Line up both a screws of each mounting plates with the slots of the arms and slide the door down.  
\* Make sure that the screws are properly inserted in the slots before releasing the door.
- (3) Fasten both a screws securely.

⚠ Do not pull the arm down as it will spring back up violently and may cause serious injuries.

### 3. Bar installation:

- (1) Cut the bar to the necessary length as per instructions in the "Model Selection" section.
- (2) Install the bar to either arm A or arm B depending on the dimensions selected above. Arm A installation is recommended for wooden doors as bar is not visible in the open position. Arm B installation is recommended for glass door as bar is less visible in the closed position.

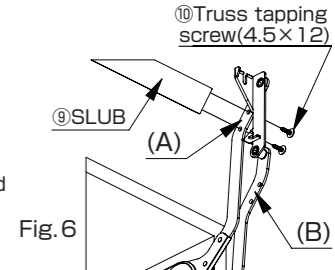

### 4. Damper installation:

#### 4. Damper installation:

- (1) Line the distance plate ⑦ and the holder ⑥ with the holes for the damper (Fig.7) and secure them with screws ⑧.
- (2) Slide the damper ⑤ into the holder from the front side.

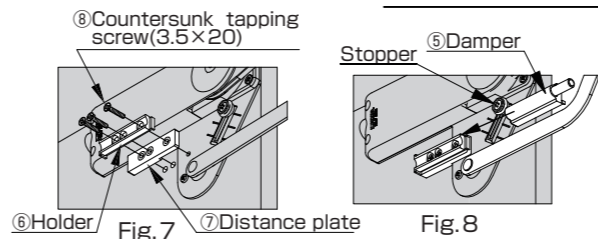

## Adjustment

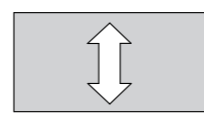

- ① Loosen both a screws
- ② Adjust height by turn b screw
- ③ Refasten both a screws securely

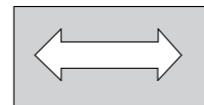

- ① Loosen both c screws
- ② Adjust door position
- ③ Refasten both c screws securely

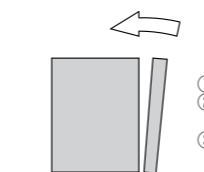

- ① Loosen both a screws
- ② Turn screw d left to bring the top of the door closer to the cabinet
- ③ Refasten both a screws securely

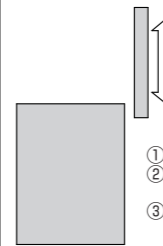
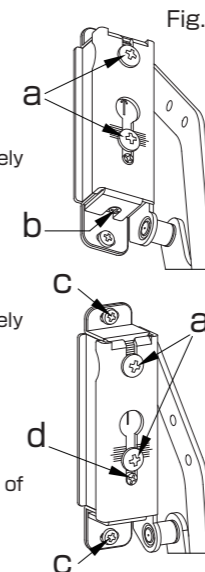

- ① Loosen both e screws on both sides
- ② Adjust height of the opened door similarly on both sides.
- ③ Refasten both e screws securely

### Spring strength adjustment:

Turn the screw at the back of stay body to adjust the spring strength.

⚠ Spring strength should be adjusted similarly on both units.  
⚠ Do not set the spring strength too high as the door may open violently and damage the system.

Fig.10

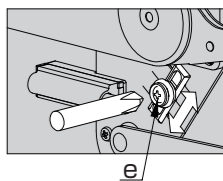

Fig.11

