

BHMA TYPE 6

Narrow Stile Concealed Vertical Rod Exit Device

For Aluminum Doors

8600 Series

LIFE-SAFETY

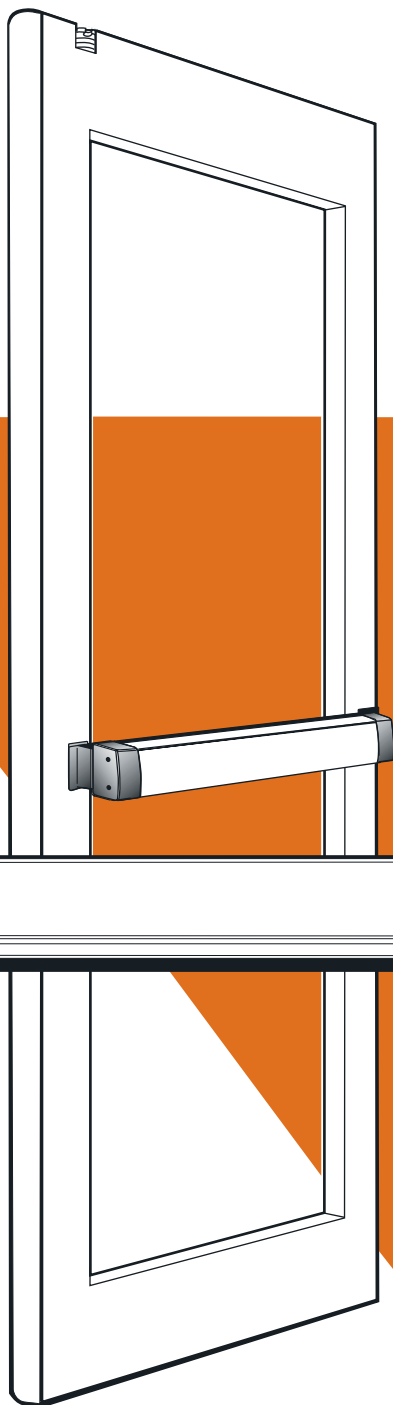
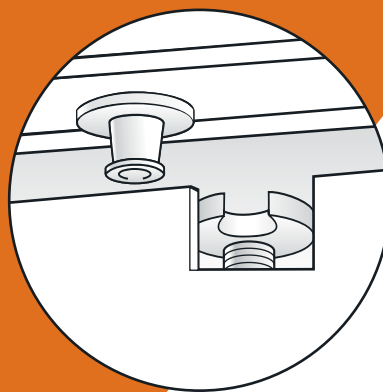

Also available
for a Midpanel
door design

CERTIFICATIONS:

UL Life-Safety Listing
ANSI/BHMA A156.3 Grade 1
California State Fire Marshall
New York City MEA*

*Consult factory for specific number

Features:

- ▼ Patented top latching mechanism interlocks door to frame
- ▼ Top and bottom adjustable steel rods
- ▼ Pushbar anodized or clad, not plated, in a variety of finishes
- ▼ Easy to install
- ▼ Clean, unobtrusive design
- ▼ Strong, durable construction for a high level of security



Features & Dimensions

Narrow Stile Concealed Vertical Rod Exit Device

ANSI/BHMA Grade 1

Handing

Device is non-handed. Lever Entry Trim is field reversible.

Pushbar Length

Standard Sizes: Dimensioned for 30", 36", 42" & 48" openings. Standard width bars can be field cut to the next smallest opening width.

Projection

2-5/8" when fully projected,
1-5/8" when dogged.

Door Thickness

Suits 1-3/4" standard, up to 2-1/4".
Device requires modification when used with cylinder in doors over 1-3/4".

Stile Wall

Doors with stile walls other than 1/8" require modification.

Stile Width

Minimum 2" Stile. Fits Narrow, Medium and Wide Stile aluminum doors.

Bar Height

Adjustable from 30" to 44".

Door Height

Standard unit adjustable for doors up to 66" above the selected bar height. For doors over 66" above bar height, up to 10' use 8655 Tall Door Kit.

Materials

Pushbar made of extruded aluminum, clad or anodized in a variety of finishes.

Dogging

Standard dogging with hex key or optional cylinder dogging. Electric dogging available.

Fasteners

Standard self-tapping screws.

Strike

Made of hardened steel. Supplied.

Cylinders (order separately)

Cylinder x Fixed Pull:

(Function 03)

Accepts any standard Mortise cylinder with MS® cam.

Entry Lever

(Functions 08, 09)

Accepts any standard diameter Mortise cylinder with MS® cam. Accommodates cylinder lengths from 1" to 1-1/4".

Warranty

Five year limited.

AVAILABLE FINISHES

313 Dark Bronze Anodized

335 Black Anodized

628 Clear Anodized

US3 Bright Brass

US4 Satin Brass

US9 Bright Bronze

US10 Satin Bronze

10B Dark Bronze
(Trim only)

US32 Bright Stainless

US32D Satin Stainless

Consult factory for special finishes.



Bolts and Strikes



Top Bolt

The patented top latching mechanism utilizes a rotating Top Bolt which deadlatches around the Header Strike, interlocking the door to the frame.



Standard Strike

Supplied with Standard Header Strike.

The hexagonal, hardened steel Bottom Bolt works in harmony with the Top Bolt.



Bottom Bolt

Pushbar Dimensions

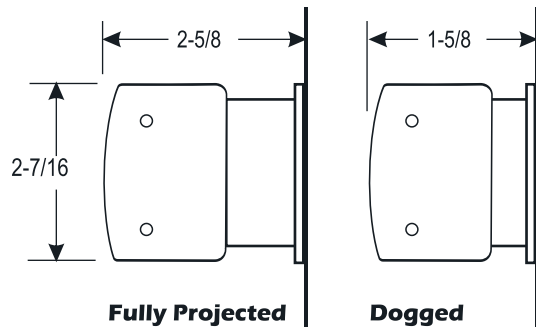
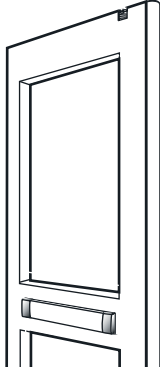

8675 Midpanel

The Concealed Vertical Rod exit device is also available for use with a Midpanel design. Consult factory for applications.

Trim & Function

Narrow Stile Concealed Vertical Rod Exit Device

ANSI/BHMA Functions:

01	02	03	08	09	14
EXIT ONLY- NO TRIM	PULL ONLY WHEN DOGGED DUMMY TRIM OR FIXED PULL BY OTHERS	KEY RETRACTS LATCHBOLT NL	KEY LOCKS/ UNLOCKS LEVER	KEY UNLOCKS LEVER NL	PASSAGE SET
CYLINDER TYPE					
N/A	N/A	MORTISE * 	MORTISE 	MORTISE 	N/A

NL – Night Latch

Please see page ED-10 or ED-11 for Pulls and Entry Trim, plus Entry Trim Ordering Matrix.

*Requires 8650 Cylinder Escutcheon

Ordering Matrix

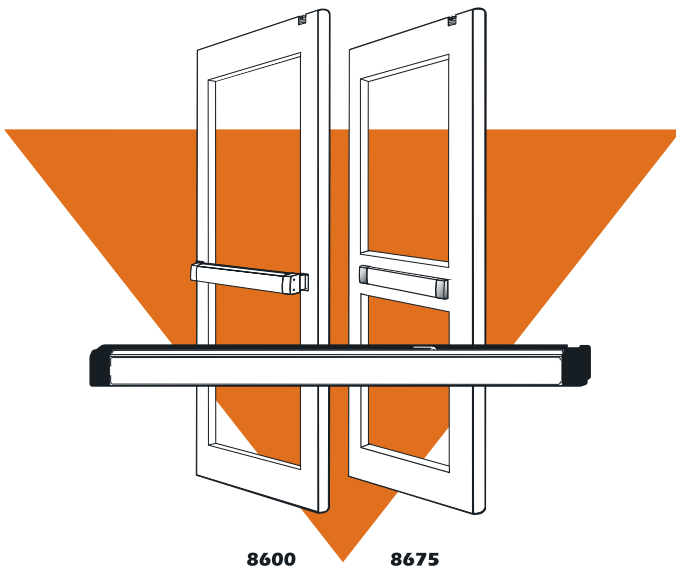

8600 Series - Life-Safety for Aluminum/Glass Doors

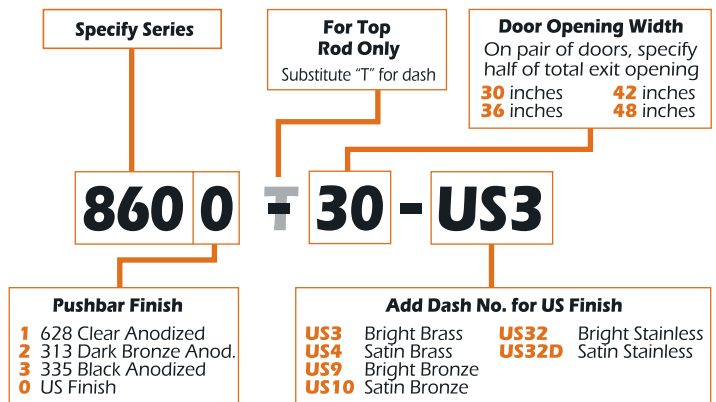

Order 8650 escutcheon kit and cylinder separately if required.

For doors up to 10 feet tall specify 8655.

If required, specify cylinder and other trim separately

Narrow Stile Concealed Vertical Rod Exit Device

Order by adding suffix to Exit Device in place of hyphen or by separate model number.

MOTORIZED LATCH RETRACTION

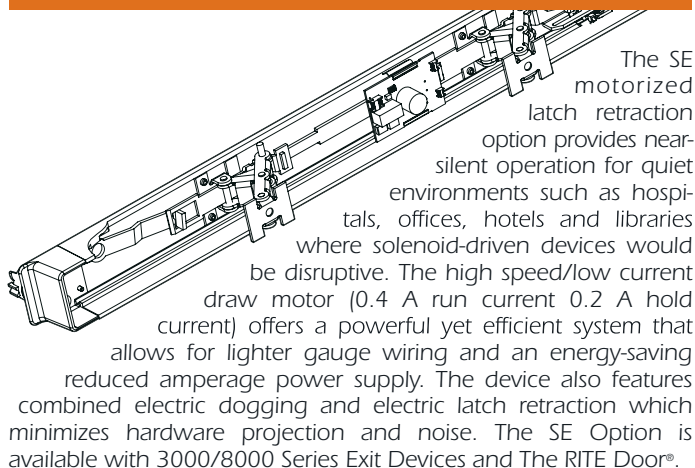

The SE motorized latch retraction option provides near-silent operation for quiet environments such as hospitals, offices, hotels and libraries where solenoid-driven devices would be disruptive. The high speed/low current draw motor (0.4 A run current 0.2 A hold current) offers a powerful yet efficient system that allows for lighter gauge wiring and an energy-saving reduced amperage power supply. The device also features combined electric dogging and electric latch retraction which minimizes hardware projection and noise. The SE Option is available with 3000/8000 Series Exit Devices and The RITE Door®.

Specify by adding "SE" after exit device model number (ex. 8611SE36).

Order PS-SE Power Supply separately. (PS-SE powers 2 devices)
Rated for continuous duty. See 4612 Power Supply.

RX - MONITOR/SIGNAL SWITCH

- M1- Single Switch
- M2- Dual Switch

Mounted in the exit device pushbar on the hinge end, the switch can be used to activate signal light, horn, monitor or other devices. Switch can be wired for normally open or normally closed. Can be retrofit in field to existing exit device. Dual switch version offers redundancy as required by some building codes or it can operate a second signaling device.

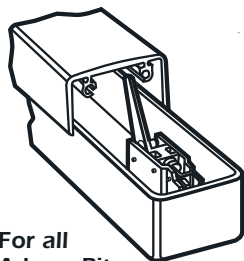

For all Adams Rite Exit Devices

Specify by adding "M1" or "M2" after exit device model number.
RX Monitor Kits for upgrading any 3000 or 8000 Series device:
91-0897-01 – Single Switch 91-0897-02 – Dual Switch

CYLINDER DOGGING

For all non-fire rated Adams Rite Exit Devices



For management control of dogging. Any standard 15/16" to 1-1/8" long Mortise cylinder with MS® cam can be used in a pushbar prepared at factory with Cylinder Dogging kit. Not for use with Alarm, EL or SE options.

ALARMED EXIT DEVICE



For all Adams Rite Exit Devices

This option emits a loud (95 decibel) alarm to notify management of unauthorized exit. Alarm is controlled by a key in any standard Mortise cylinder with MS® cam to arm, disarm, delay or reset the alarm. Will not alter the Life-Safety characteristics of the exit device in any way. Red letters printed on the bar give a "hands off" warning to deter accidental actuation.

Battery Operated

Four AA alkaline batteries power twin horns for two minutes (or until disarmed) when pushbar is depressed. Beeps to signal need for new batteries.

Minimum opening width: 36"

ELECTRIC DOGGING

For all Adams Rite Exit Devices



The "ED" option's holding magnet keeps the pushbar depressed (set manually) and the latch retracted for a lower profile exit device, resulting in less damage and quieter operation. An internal microswitch signals when the bar is depressed – ideal for automatic door operators. On fire-rated devices, it's wired through the fire alarm system. Devices operate at 24VDC at .6 amps, with only a transformer and rectifier. (Not to be used as access control element. Specify "EL" with access control devices.)

Specify by adding "ED" after exit device model number (ex. 8611ED36).

MONITORED DUMMY PUSHBAR

- 8099M1 - Single Switch
- 8099M2 - Dual Switch
- 8099-00 - Dummy Only



Dummy pushbar with no latch mechanism but with either a single or dual monitor/signal switch. Can be used with a maglock, where bar turns off magnet and allows exit from building. Dual switch version allows redundancy where required by code or the operation of a signal device. Specify door type and width when ordering.